

DRAWING

CUSTOMER :

accept stamp

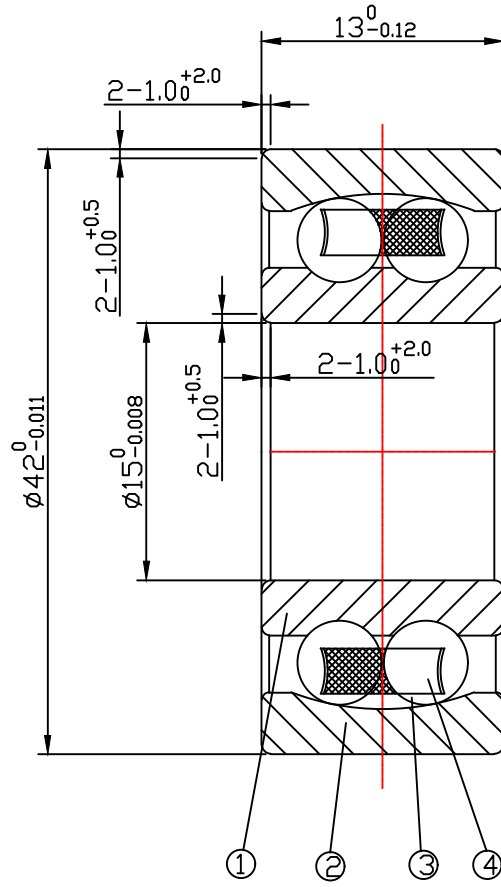

issue stamp

BRAND: NBK

ALL DIMENSIONS: mm

MARKER	PLACES	BEFORE	REVISER	REVISION DATE

NOTIONS:

NO.	PARTS	MATERIAL	QUANTITY	REMARKS
1	INNER RING	GCr15	1	
2	OUTER RING	GCr15	1	
3	BALLS	GCr15	2*10- $\phi 6.35$	
4	RETAINER	NYLON	1	

LOAD RATING STATIC: COr: 2330 N

LOAD RATING DYNAMIC: Cr: 9850 N

RADIAL PLAY: C0 0.008-0.021

TOLERANCES: ABEC-1

CUSTOMER SIZE:

SIZE: 1302

庄宏亿
2024-6-28
陈晶晶

庄宏亿
2024-6-28
陈丹央

庄宏亿
2024-6-28
周宝君

DRAWING NO. : QAJ/TR24225

draw

check

approved

DATE:

Jun.28,2025

NBK NINGBO CHUANG HON YI BEARING CO.,LTD.