

DRAWING

CUSTOMER :

accept stamp

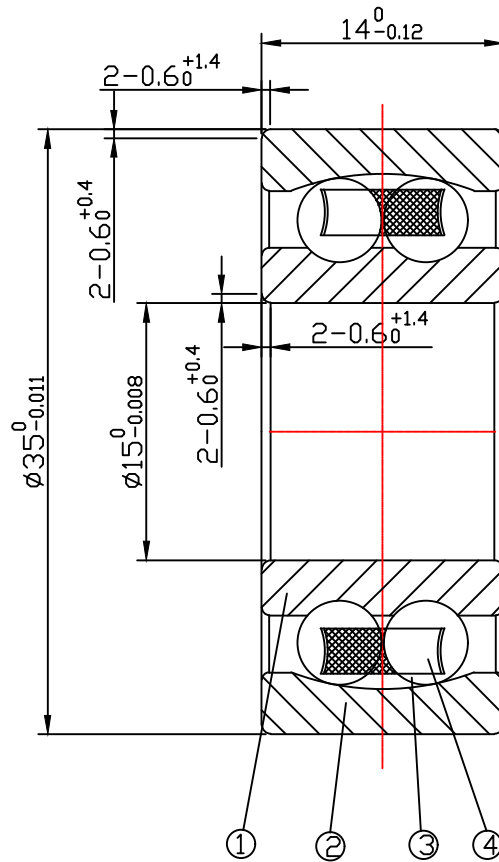

issue stamp

BRAND: NBK

ALL DIMENSIONS: mm

NOTIONS:

MARKER	PLACES	BEFORE	REVISER	REVISION DATE

NO.	PARTS	MATERIAL	QUANTITY	REMARKS
1	INNER RING	GCr15	1	
2	OUTER RING	GCr15	1	
3	BALLS	GCr15	2*9- $\phi 6.35$	
4	RETAINER	NYLON	1	

LOAD RATING STATIC: COr: 2250 N

LOAD RATING DYNAMIC: Cr: 9720 N

RADIAL PLAY:  
C0 0.008-0.021

TOLERANCES: ABEC-1

CUSTOMER SIZE:

SIZE:  
2202

DRAWING NO. : QAJ/TR24224

庄宏亿  
2024-6-28  
陈晶晶

庄宏亿  
2024-6-28  
陈丹央

庄宏亿  
2024-6-28  
周宝君

draw

check

approved

DATE:

Jun.28,2025

**NBK** NINGBO CHUANG HON YI BEARING CO.,LTD.