

DRAWING

CUSTOMER :

accept stamp

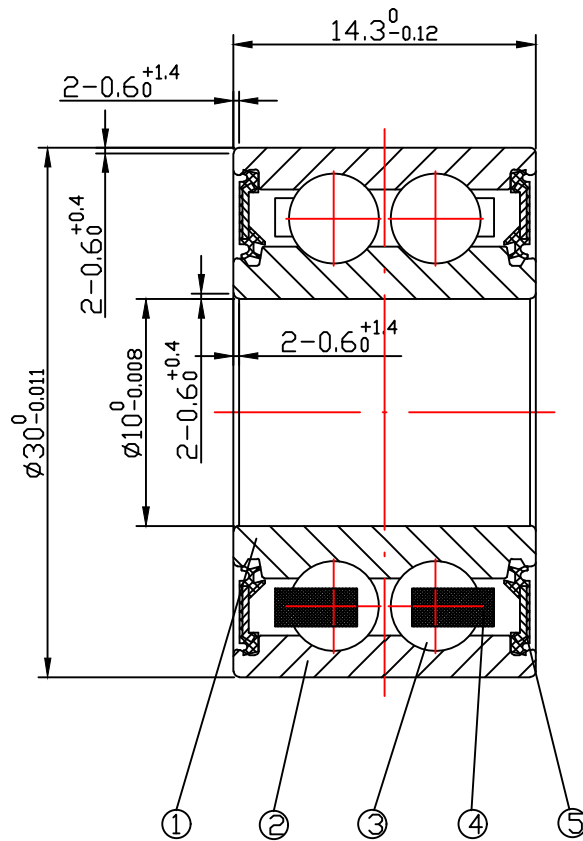

issue stamp

BRAND: NBK

ALL DIMENSIONS: mm

NOTIONS:

MARKER	PLACES	BEFORE	REVISER	REVISION DATE

NO.	PARTS	MATERIAL	QUANTITY	REMARKS
1	INNER RING	GCr15	1	
2	OUTER RING	GCr15	1	
3	BALLS	GCr15	2*8- $\phi 4.763$	
4	RETAINER	NYLON	1	
5	SEAL	NBR	2	

LOAD RATING STATIC: COr: 4790 N

LOAD RATING DYNAMIC: Cr: 7880 N

RADIAL PLAY: 0.002-0.013

TOLERANCES: ABEC-1

CUSTOMER SIZE:

SIZE: 5200-2RS

庄宏亿
2024-6-27
陈晶晶

庄宏亿
2024-6-27
陈丹央

庄宏亿
2024-6-27
周宝君

DRAWING NO. : QAJ/TR24218

draw

check

approved

DATE:

Jun.27,2025

NBK NINGBO CHUANG HON YI BEARING CO.,LTD.