

DRAWING

CUSTOMER :

accept stamp

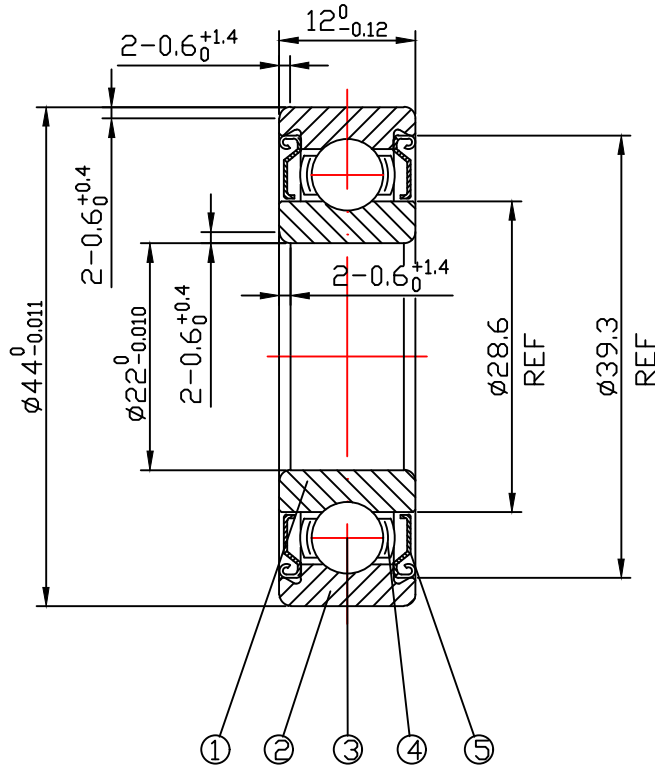

issue stamp

BRAND: NBK

ALL DIMENSIONS: mm

NOTIONS:

MARKER	PLACES	BEFORE	REVISER	REVISION DATE

NO.	PARTS	MATERIAL	QUANTITY	REMARKS
1	INNER RING	GCr15	1	
2	OUTER RING	GCr15	1	
3	BALLS	GCr15	9- $\phi 6.747$	
4	RETAINER	SPCC	1	
5	SHIELD	SPTe	2	

LOAD RATING STATIC: COr: 5730 N

LOAD RATING DYNAMIC: Cr: 10470 N

RADIAL PLAY: C0: 0.005-0.020

TOLERANCES: ABEC-1

CUSTOMER SIZE:

SIZE: 60/22ZZ

DRAWING NO. : QAJ/TR23225

庄宏亿
2023-7-3
陈晶晶

庄宏亿
2023-7-3
陈丹央

庄宏亿
2023-7-3
周宝君

draw

check

approved

DATE: Jul.3,2023

NBK NINGBO CHUANG HON YI BEARING CO.,LTD.