

DRAWING

CUSTOMER :

accept stamp

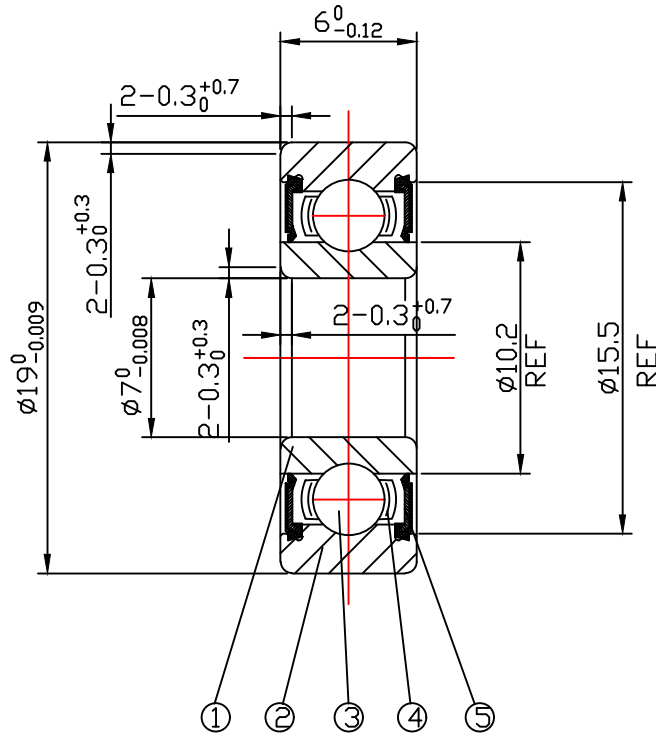

issue stamp

BRAND: NBK

ALL DIMENSIONS: mm

NOTIONS:

MARKER	PLACES	BEFORE	REVISER	REVISION DATE

NO.	PARTS	MATERIAL	QUANTITY	REMARKS
1	INNER RING	GCr15	1	
2	OUTER RING	GCr15	1	
3	BALLS	GCr15	7- $\phi 3.175$	
4	RETAINER	SPCC	1	
5	SEAL	NBR	2	

LOAD RATING STATIC: COr: 903 N

LOAD RATING DYNAMIC: Cr: 2230 N

RADIAL PLAY: C0: 0.002-0.013

TOLERANCES: ABEC-1

CUSTOMER SIZE:

SIZE: 607-2RS

DRAWING NO. : QAJ/TR24037

庄宏亿
2024-4-24
陈晶晶

庄宏亿
2024-4-24
陈丹央

庄宏亿
2024-4-24
周宝君

draw

check

approved

DATE: Apr.24,2024

NBK NINGBO CHUANG HON YI BEARING CO.,LTD.