

DRAWING

CUSTOMER :

accept stamp

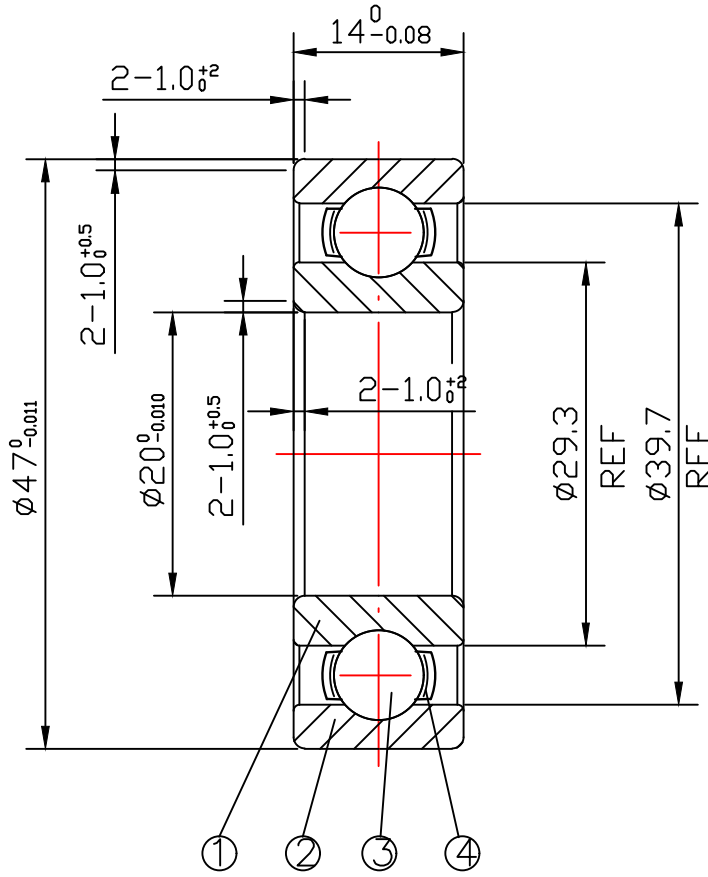

issue stamp

BRAND: NBK

ALL DIMENSIONS: mm

MARKER	PLACES	BEFORE	REVISER	REVISION DATE

NOTIONS:

NO.	PARTS	MATERIAL	QUANTITY	REMARKS
1	INNER RING	GCr15	1	
2	OUTER RING	GCr15	1	
3	BALLS	GCr15	8-ø7.938	
4	RETAINER	SPCC	1	

LOAD RATING STATIC: COr: 6650 N

LOAD RATING DYNAMIC: Cr: 12830 N

RADIAL PLAY: C0: 0.005-0.020

TOLERANCES: ABEC-1

CUSTOMER SIZE:

SIZE: 6204

庄宏亿  
2024-7-3  
陈晶晶

庄宏亿  
2024-7-3  
陈丹央

庄宏亿  
2024-7-3  
周宝君

DRAWING NO. : QAJ/TR24261

draw

check

approved

DATE:

Jul.3,2024

**NBK** NINGBO CHUANG HON YI BEARING CO.,LTD.