

DRAWING

CUSTOMER :

accept stamp

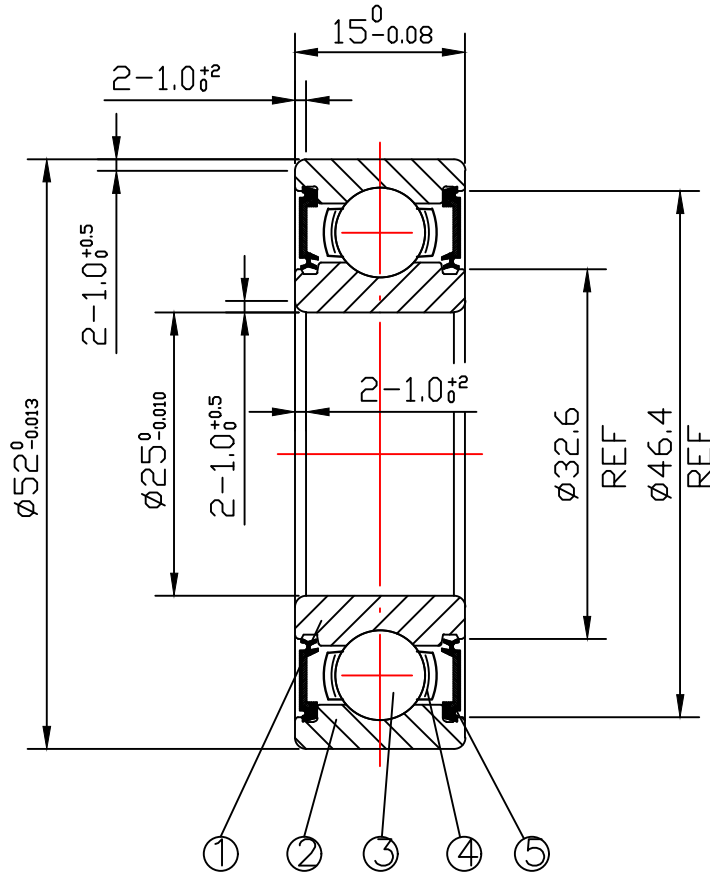

issue stamp

BRAND: NBK

ALL DIMENSIONS: mm

NOTIONS:

MARKER	PLACES	BEFORE	REVISER	REVISION DATE

NO.	PARTS	MATERIAL	QUANTITY	REMARKS
1	INNER RING	GCr15	1	
2	OUTER RING	GCr15	1	
3	BALLS	GCr15	9- $\phi$ 7.938	
4	RETAINER	SPCC	1	
5	SEAL	NBR	2	

LOAD RATING STATIC: COr: 7930 N

LOAD RATING DYNAMIC: Cr: 14020 N

RADIAL PLAY: C0: 0.005-0.020

TOLERANCES: ABEC-1

CUSTOMER SIZE:

SIZE: 6205-2RS

DRAWING NO. : QAJ/TR24070

庄宏亿  
2024-4-30  
陈晶晶

庄宏亿  
2024-4-30  
陈丹央

庄宏亿  
2024-4-30  
周宝君

draw

check

approved

DATE:

Apr.30,2024

**NBK** NINGBO CHUANG HON YI BEARING CO.,LTD.