

DRAWING

CUSTOMER :

accept stamp

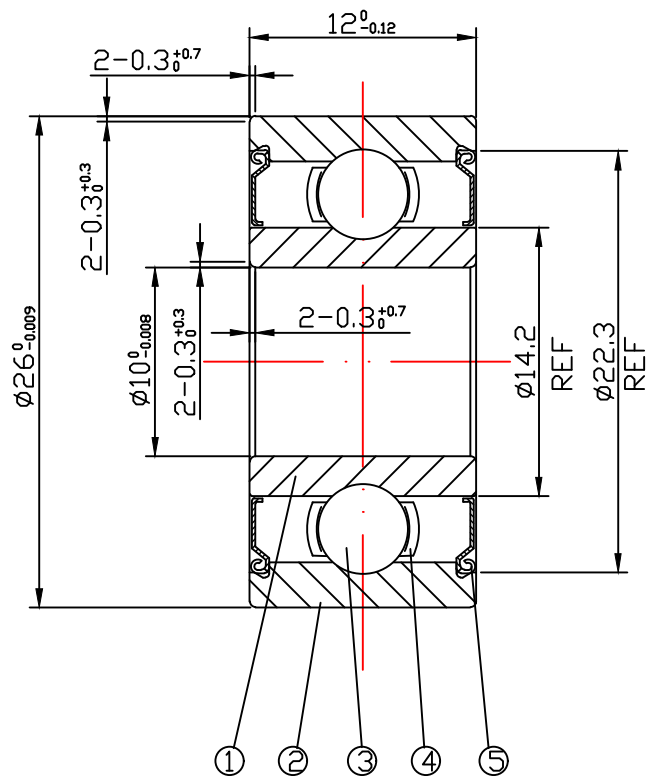

issue stamp

BRAND: NBK

ALL DIMENSIONS: mm

NOTIONS:

MARKER	PLACES	BEFORE	REVISER	REVISION DATE

NO.	PARTS	MATERIAL	QUANTITY	REMARKS	LOAD RATING STATIC: COr: 1950 N
1	INNER RING	GCr15	1		LOAD RATING DYNAMIC: Cr: 4550 N
2	OUTER RING	GCr15	1		RADIAL PLAY: C0: 0.002-0.013
3	BALLS	GCr15	7- $\phi$ 4.763		TOLERANCES: ABEC-1
4	RETAINER	SPCC	1		CUSTOMER SIZE:
5	SHIELD	SPTe	2		SIZE: 63000ZZ
					DRAWING NO. : QAJ/TR23253
					<b>NBK</b> NINGBO CHUANG HON YI BEARING CO.,LTD.

庄宏亿  
2023-11-13  
陈晶晶

庄宏亿  
2023-11-13  
陈丹央

庄宏亿  
2023-11-13  
周宝君

draw

check

approved

DATE:

Nov.13,2023