

DRAWING

CUSTOMER :

accept stamp

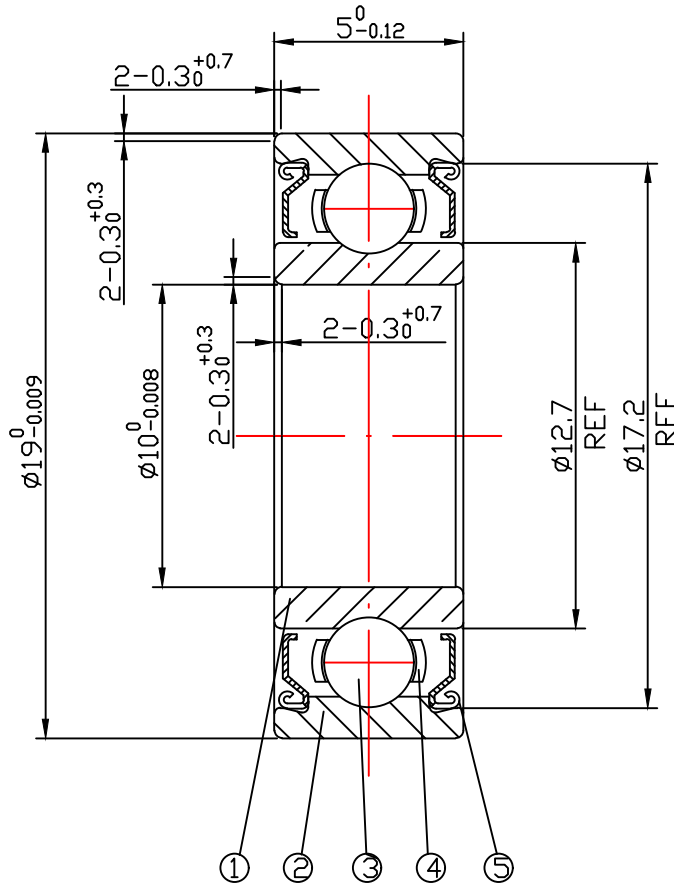

issue stamp

BRAND: NBK

ALL DIMENSIONS: mm

MARKER	PLACES	BEFORE	REVISER	REVISION DATE

NOTIONS:

NO.	PARTS	MATERIAL	QUANTITY	REMARKS
1	INNER RING	GCr15	1	
2	OUTER RING	GCr15	1	
3	BALLS	GCr15	9- ϕ 2.381	
4	RETAINER	SPCC	1	
5	SHIELD	SPTE	2	

LOAD RATING STATIC: COr: 760 N

LOAD RATING DYNAMIC: Cr: 1590 N

RADIAL PLAY: C0: 0.002-0.013

TOLERANCES: ABEC-1

CUSTOMER SIZE:

SIZE: 6800ZZ

庄宏亿
2023-11-13
陈晶晶

庄宏亿
2023-11-13
陈丹央

庄宏亿
2023-11-13
周宝君

DRAWING NO. : QAJ/TR23269

draw

check

approved

DATE: Nov.13,2023

NBK NINGBO CHUANG HON YI BEARING CO.,LTD.