

DRAWING

CUSTOMER :

accept stamp

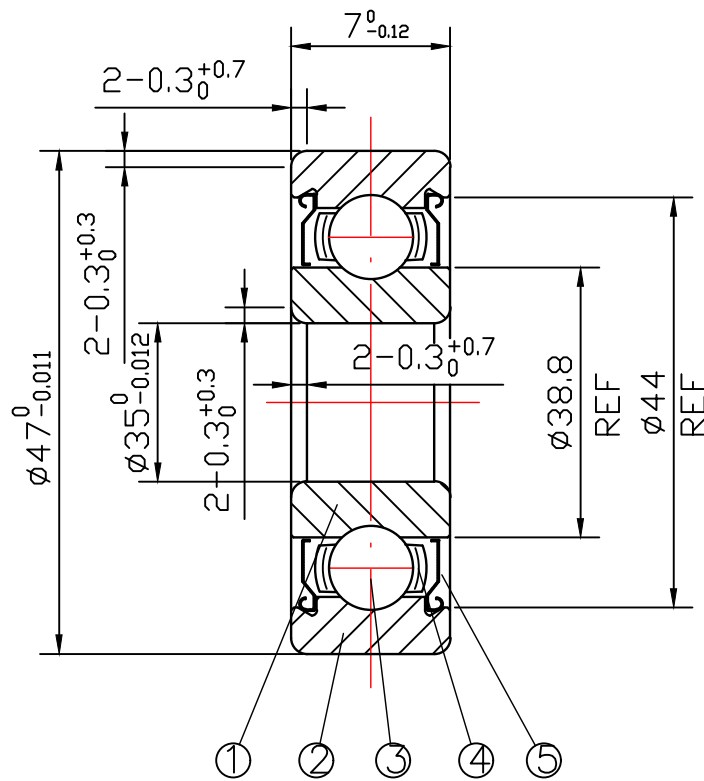

issue stamp

BRAND: NBK

ALL DIMENSIONS: mm

NOTIONS:

MARKER	PLACES	BEFORE	REVISER	REVISION DATE

NO.	PARTS	MATERIAL	QUANTITY	REMARKS
1	INNER RING	GCr15	1	
2	OUTER RING	GCr15	1	
3	BALLS	GCr15	22- $\phi 3.175$	
4	RETAINER	SPCC	1	
5	SHIELD	SPTE	2	

LOAD RATING STATIC: COr: 3610 N

LOAD RATING DYNAMIC: Cr: 4310 N

RADIAL PLAY:

C0: 0.006-0.020

TOLERANCES: ABEC-1

CUSTOMER SIZE:

SIZE:

6807ZZ

DRAWING NO. : QAJ/TR23276

庄宏亿  
2023-11-13  
陈晶晶

庄宏亿  
2023-11-13  
陈丹央

庄宏亿  
2023-11-13  
周宝君

draw

check

approved

DATE:

Nov.13,2023

NBK NINGBO CHUANG HON YI BEARING CO.,LTD.